

User manual

AC EV Charger

TACEV001 7KW (11kw/22kw)



Safety and Warning

Save these instructions. Read all instructions before installing or using the charger.

- 1) Keep the charging plug from explosive or flammable materials, chemicals, vapors and other hazard objects.
- 2) Keep the charger socket clean and dry. If it gets dirty, please wipe it with clean dry cloth.
- 3) Touching the plug core is strictly forbidden when power on.
- 4) Do not use the charger in case of any device defects, crack, abrasion, bare leakage and so on. Please contact the professional personnel if any of these conditions occurs.
- 5) Do not attempt to disassemble, repair the charger. If necessary, please contact the professional personnel. Improper operation will result in device damage, electric leakage, etc.
- 6) In case any abnormal condition happens, please press the emergency stop button and cut off all input and output power supplies immediately.
- 7) When the Bluetooth APP and LED indicator display fault information, please refer to 4.2 Fault Code and Resolution. Still can not solve the problem do not blindly operate, please contact professionals.
- 8) Please protect charging carefully from rain and thunder.
- 9) Keep children away from the charger.
- 10) During charging, do not drive the EV, keep the EV stationary, for hybrid cars, charge only when the engine is switched off.

Warning



Hazardous voltage that gives risk of electrocution



General risk



PE

The input and output voltages of this device are high voltage, which threaten human life safety. Please strictly observe all warnings on the device and user manual. Unauthorized and non-professional service personnel are forbidden to remove the cover of this device.

CONTENT

1 Product Introduction

1.1 Product Description	01
1.2 Product Characteristic	02
1.3 Product Technical Specifications	03
1.4 External Structure	04
1.5 Package Contents	05

2 Installation Instruction

2.1 Installation Preparation	06
2.2 Wall Mounting Process	07
2.3 Column Mounting Process	09

3 Configuration and Operation

3.1 Power-on Checking	11
3.2 Start and stop charging by your charge card	11
3.3 Start and stop charging by APP(Bluetooth)	12

4 Indication and Fault

4.1 Indicator Status	14
4.2 Fault Code and Resolution(Bluetooth APP display)	15

5 Warranty and Service

5.1 Customer Service	16
5.2 After Service	16
5.3 About	16

1 Product Introduction

1.1 Product Description

The TACEV001 7KW (11kw/22kw) is a basic AC EV Charger, which include wall-mounting and column-mounting. Suitable for scenarios such as home and business. Easy to install and simple to operate. The shell is simple and elegant, the equipment performance is superior, and it has all-round protection functions. IP65 protection level, good dust-proof and waterproof performance, Type A+6mA DC leakage protection, accurate measurement of charging data. Suitable for indoor and outdoor. Support a variety of charging modes, such as plug and play charging, swipe charging, APP charging, scan code charging. Compatible with Bluetooth/WiFi/Ethernet/4G and other communication functions.

1.2 Product Characteristic



APP Display(Bluetooth APP)

APP can display the real-time charging status, including time, voltage, current, power and so on.

All-round protection

Include voltage protection, current protection, leakage protection, temperature protection, lightning protection and other protective measures to ensure the safety.

IP65, Strong and Durable

Support outdoor harsh environment, waterproof and dustproof. Rugged shell which could resist the rolling and crash of the car.

High intelligence

Powerful information collection, transmission and communication functions, supporting Bluetooth, Ethernet, 4G and WIFI wireless communication.

Easy to install and use

The installation process is simple, payment is convenient and fast, supports mobile application software or IC card swiping. Fully compatible with all EV in the market.

1.3 Product Technical Specifications

Parameter type	Description	PEVC2108E	
Input parameters	Power Supply	1P+N+PE	3P+N+PE
	Rated voltage	230VAC ± 10%	400VAC ± 10%
	Frequency	50Hz/60Hz	
Output parameters	Number of output ports	1	
	Rated voltage	230VAC ± 10%	400VAC ± 10%
	Rated current	16A/32A	
	Rated power	3.7kW/7.4kW	11kW/22kW
Safety	Electrical protection	Over/under voltage protection, Over current protection, Short circuit protection, Over temperature protection, Lightning protection, ground protection	
	RCD	Type A + 6mA DC	
	Protection level	IP65	
	Impact protection	IK08	
	Certification	CE	
	Standards	IEC61851-1, IEC62196-1/2	
Environmental	Operating temperature	-30°C~+50°C	
	Storage temperature	-40°C~+80°C	
	Altitude	2000m	
	Humidity	95%, non-condensing	
Basic parameters	Energy Metering	Accuracy Class 1.0 Embedded Metering	
	HMI	APP	
	Plug cable length	5m	
	Communication	Bluetooth/WiFi/ Ethernet/ 4G LTE	
	Protocol	OCPP-1.6 (JSON)	
	Connector type	Type 2	
	Installation method	Wall-mount/column-mount	
	Shell color	Metallic grey	
	Shell material	(ABS+PC)-Blend	
Start mode	Plug&play/RFID card/APP		

1.4 External Structure

Wall Mounting

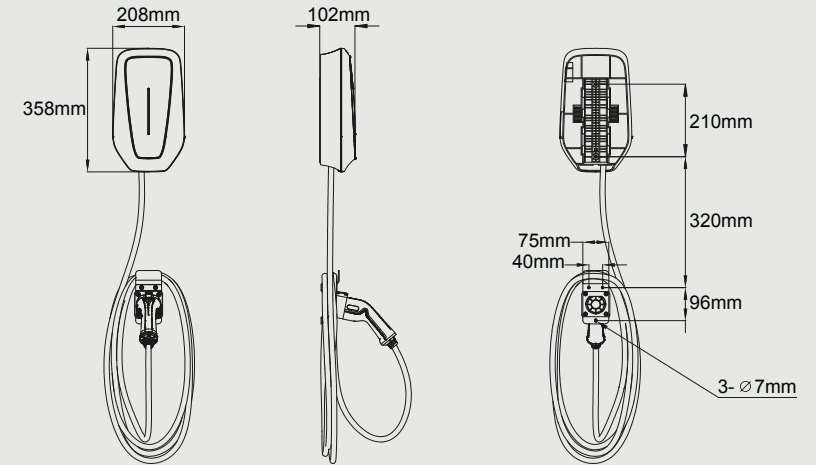



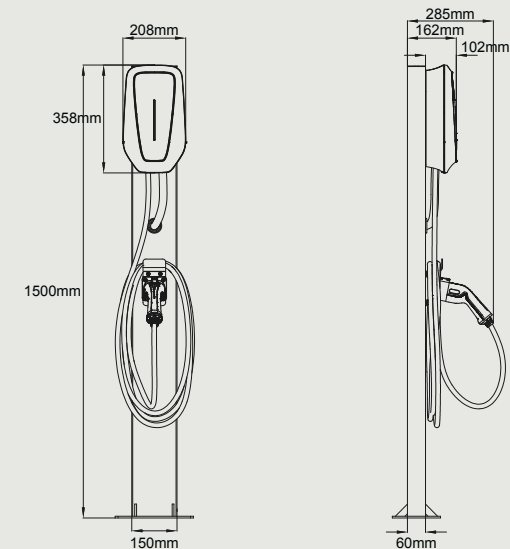



Column Mounting



1.5 Package Contents

Unpack the product. Please check and verify following items after receiving the charger:

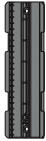
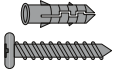

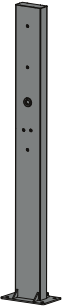

- 1) Visual inspection on charger's external appearance. If there is any breakage or other damage, please notify the seller immediately.
- 2) Check type and quantity of all accessories as follows. If there is a shortage in the quantity of any items or if any items are missing, please contact the seller at once.

General parts					
					
User manual (x1)	RFID card (Card swiping version only) (x2)	Certificate (x1)	Hook (x1)	bellows (x1)	Bracket(The bracket on the rear housing) (x1)
Wall Mounting		Column Mounting			
					
Expansion bolt M6×70 (x5)		Combination screw M6×20 (x5)	Expansion bolt M8×70 (x4)		Column (x1)

2 Installation Instruction

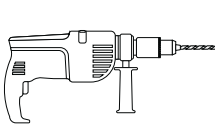
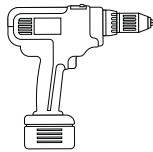
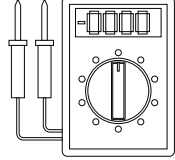
2.1 Installation Preparation

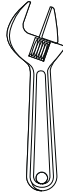
Please prepare the following tools before installation:

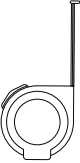
			
Hammer drill and drill bit (22 mm, 7 / 8 inch)	Electric drill	Multimeter	Hammer
			
screwdriver M4(length)<100	Adjustable wrench	Diagonal Pliers	Measuring tape (5m)

⚠ Installation Notice

- Electrical devices should only be installed, operated, and maintained by qualified technician. No responsibility is assumed by the manufacturer for any consequences arising out of the use of this device.
- When installing wires, do not turn on the power supply.
- The length of the power cable and communication cable should be properly reserved to facilitate installation and connection.
- Pay attention to protect the charger enclosure during installation to prevent bumping, scratching the surface, etc.
- The charger must be installed vertically, and the deviation of any direction from the vertical position should not exceed 5°.

2.2 Wall Mounting Process

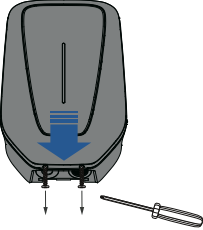
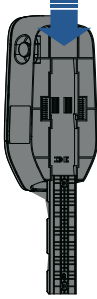
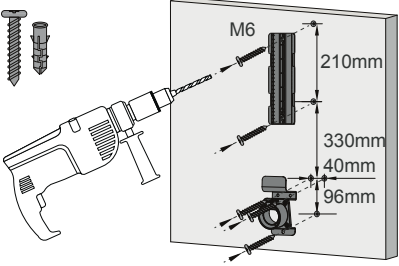
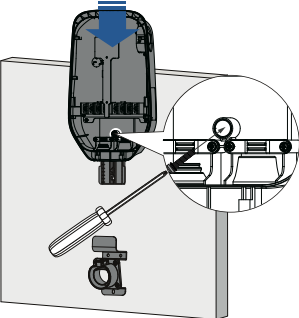
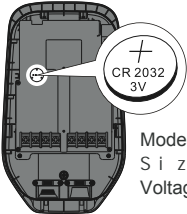
 <p>1) Remove the two screws (M4) on the front cover. Press the top of the front cover and slide it down, and then remove the internal screw (M6).</p>	 <p>2) Remove the bracket on the rear housing.</p>
 <p>3) Use the bracket and hook to mark drill holes, place the anchors and fix the bracket and hook to the wall with nuts (x5).</p>	 <p>4) Hang the charger station on its bracket from top to down, open the station cover, tighten the screw connected to bracket's stud.</p>
 <p>CR2032 battery shall be selected</p> <p>Model: CR2032 Size: 20.0 X 3.2 mm Voltage: 3.0V</p> <p>5) Put the positive pole of CR2032 battery upward into the battery holder.</p>	

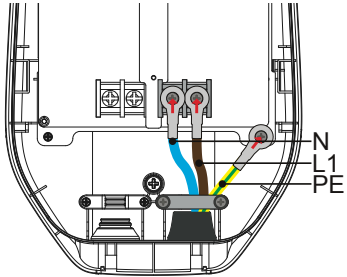
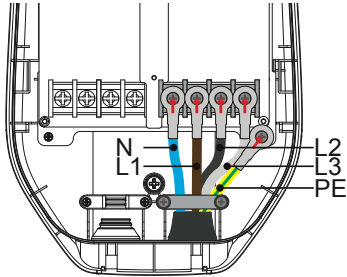
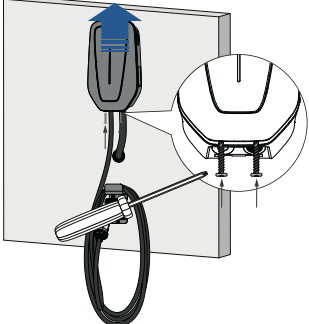
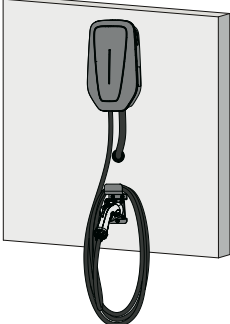
<p>1P+N+PE</p> 	<p>3P+N+PE</p> 
<p>6) Pass the power cable through the bigger cable gland, crimp power terminal from the end of the power cable to be connected to the internal circuit breaker. Connect the ground wire(PE), neutral wire(N) and each phase(L) to the AC input configuration board. Suggested input wire size 10mm².</p> <p>⚠ Certified Circuit Breakers should be installed upstream close to the charging station, or build in RCD. Circuit breaker, if any, shall comply with standard with IEC 60898-1 or IEC 60947-2 or IEC 60364-4-41. Chosen with appropriated technical specification, ie working voltage >= charging station working voltage, working current >= charging station working current, Ingress Protection (IP) >= IP54 or installed inside IP54 protection box for outdoor use.</p>	
 <p>7) Hold down the top of the front cover and slide up, Close the charger cover, tighten the side screws(x2).</p>	 <p>8) Complete installation and start to test and charge.</p>

2.3 Column Mounting Process

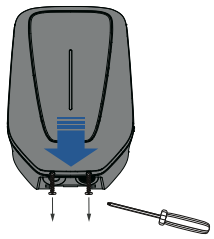

1) Remove the two screws (M4) on the front cover. Press the top of the front cover and slide it down, and then remove the internal screw (M6).

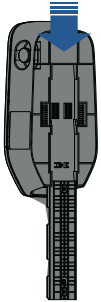

2) Remove the bracket on the rear housing.

Power	PVC size
7kW	DN40
11kW	DN50
22kW	DN80

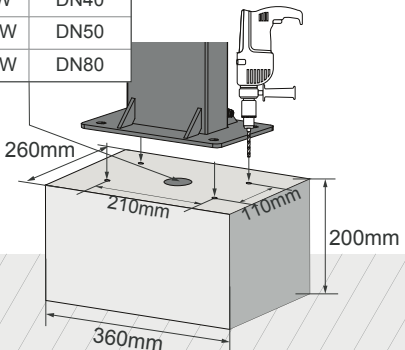

3) Make concrete platform, mark the holes position of installation column and drill holes.

Dimensions: 360mm (width), 210mm (depth), 260mm (height), 110mm (width of top section), 200mm (height of top section).

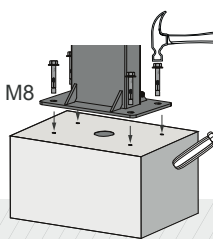

4) Install expansion bolts in the base mounting holes. Fix the column on the concrete platform with expansion bolts (x4).

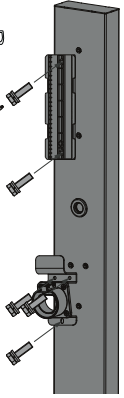

5) Install the bracket on the column (x5).

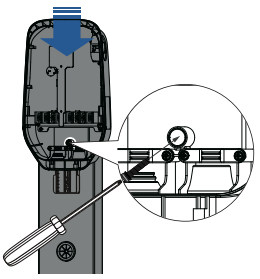

6) Hang the charger station on its bracket from top to down, open the station cover, tighten the screw connected to bracket's stud.

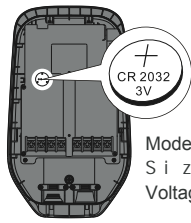

7) Put the positive pole of CR2032 battery upward into the battery holder.

CR2032 battery shall be selected
Model: CR2032
Size: 20.0 x 3.2 mm
Voltage: 3.0V

1P+N+PE

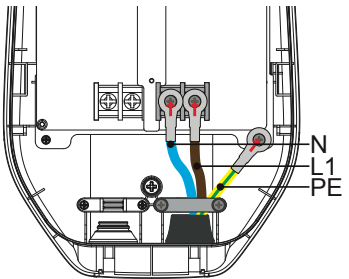

8) Refer to wall mounting wiring instruction.

3P+N+PE

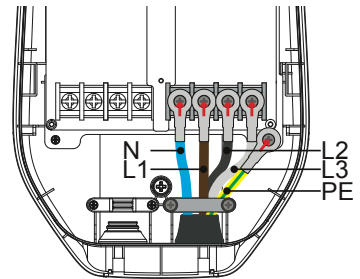

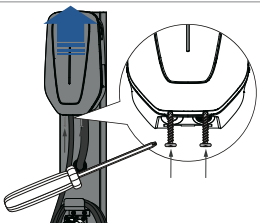

9) Hold down the top of the front cover and slide up, Close the charger cover, tighten the side screws (x2).

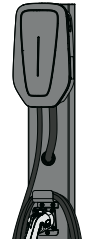

10) Complete installation and start to test and charge.

3 Configuration and Operation

3.1 Power-on Checking

Please check / re-check the following items **Power-on:**

- 1) The location of the charger should be convenient for operational and maintenance.
- 2) Before installation of the charger, ensure that the AC input component in the power supply is properly installed with the required protection.
- 3) Double confirm the charger is installed properly.
- 4) No components or other items have been left inside of the charger.

3.2 Start and stop charging by your charge card

Start charging

- 1) Plug charger gun into EV car and LED light turn to blue blinking.
- 2) Hold your RFID card in front of the reader, waiting 3 seconds.

Stop charging

- 1) Waiting LED light turns to blue-green light blinking alternately, hold your charge card (RFID Card) in front of the reader, waiting 3 seconds.
- 2) The buzzer rings, unplug charging cable from your car and place the charging cable back into cable holder.
- 3) LED light turns to green breathing state, equipment returns to idle state.

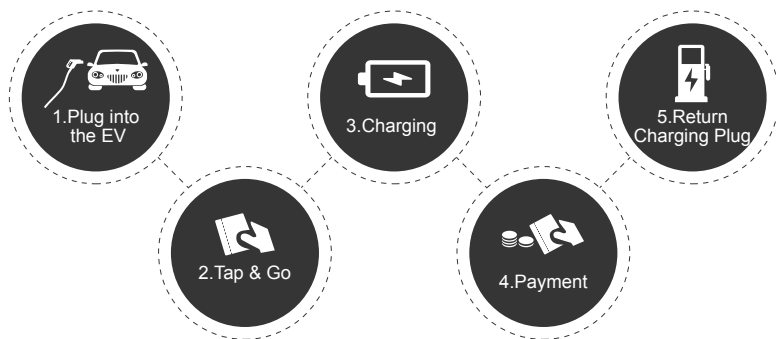

3.3 Start and stop charging by APP(Bluetooth)

Please Download APP and read "Bluetooth APP Operation Instructions" for more information.

Step 1 Download APP

 Apple APP

▶

 SINO ENERGY

▶

 Android APP

▶

 SINO

1. Download the APP either by scanning the QR code or from the Apple / Android APP Store.

Step 2 Version select



2.1 Version Select: home charger select Home version and non household charger select Pro version.



2.2 Version Select confirm.

Step 3 Bluetooth connect



3.1 Turn on the phone's bluetooth. You can click Scand code icon(scand charger QR code) to connect charger or click Add new device icon to enter the search page. If you have used it before, you can click the head directly to select the device to connect.



3.2 After entering the search page, find the available Bluetooth devices, and then click connect icon.

Step 4 Verify a user login

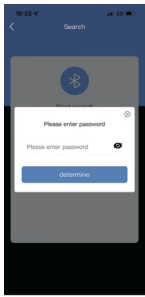

4.1 Please enter the correct password to login in. The initial password is 4567. Change the password after successful login. You should remember the password because it is very important for you next time log in charger and APP. Modify path: Modification-->Device parameters-->Change Password



4.2 If the connection and password is correct, it will login in the home page.

Step 5 Start charging



5.1 Connect your EV car with the charger gun.

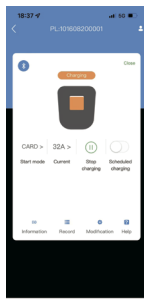

5.2 Click the start charging icon and start charging.

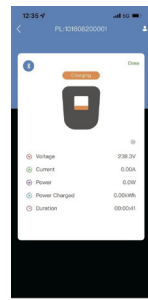

5.3 Click on the startup information icon to display charging information in real-time.

Step 6 Stop charging

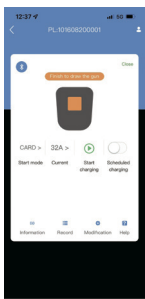

6.1 Click the stop charging icon will stop charging, then unplug the gun to complete the charging.

Fault status



The fault code table is detailed in 4.2

4 Indication and Fault

4.1 Indicator Status

	LED Light Status	Description of Charging status
	Green	Standby state
	Blue Blinking	Ready state
	Blue	Charging state
	Green/Blue Blinking	Charging stop
	Red	Error state

4.2 Fault Code and Resolution(Bluetooth APP display)

Fault Code	Fault Status	Troubleshooting suggestion
0x0001	RTC fault	Please contact after-sales service.
0x0004	Card reader fault	Check whether the connecting cable of the card reader is loose.
0x0010	EPO fault	Reset emergency stop button.
0x0020	Over voltage alarm	Check whether the input voltage of the equipment is too high.
0x0080	Under voltage alarm	Check whether the input voltage of the equipment is too low.
0x0200	FRAM fault	Please contact after-sales service.
0x1000	Flash fault	Please contact after-sales service.
0x2000	PE fault	Please check whether the PE wire are correctly connected.
0x0002	Electric meter fault	Check whether the meter connecting wire is loose.
0x0400	Relay fault	Please contact after-sales service.
0x0040	Under maintenance	Set unavailable from server, Please contact the operator or after-sales service.
0x8000	Over temperature alarm	Stop using for a period of time and wait for the equipment to return to the normal temperature range and restart.
0x0800	RCD fault	Please contact after-sales service.

Notes: In light of product hardware upgrades, certain models have undergone partial functionality removal.

5 Warranty and Service

5.1 Customer Service

We can provide customers with professional product advice and purchase options. All emails will be responded within 48 hours during working days. We provide online customer service in multiple languages. You can communicate with ease, or contact us through email anytime.

5.2 After Service

Please refer to the contract for the warranty period. The specific after-sale plan will be free for replacement or charging a certain maintenance cost according to the specific situations. During the warranty period, customers can apply for replacement or free maintenance for the fault damage caused by product quality. For the fault damage caused by other reasons (human factors, natural factors, etc.), we will provide paid maintenance services.

5.3 About

About